



**Your advantages with our products**

- » Economical and reliable Allrounder
- » Suitable for all common tile roofs / snow load zones
- » Optimal adaptability to the roof with 2 mm or 5 mm shims
- » Height of rail easily adjustable with pre-installed Clamp Combination (switch with Clamp Combination vertical, item no. 11105-05 for a vertical rail installation)
- » Installer-friendly “top-down” design: just place the rail onto the Clamp Combination. One screw fixates the rail and locks in the height at the same time.
- » Only one tool required: Torx TX40
- » Installation as single- or cross-rail system
- » Material: Stainless steel, welded



**SL A2-35**

Item no. 13135-01  
35 mm  
foot height

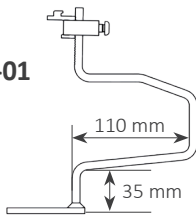

**SL A2-45**

Item no. 13145-01  
45 mm  
foot height

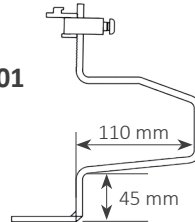

**SL A2-45 X**

Item no. 13145-02  
45 mm  
foot height,  
high snow load

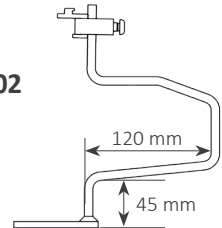

**SL A2-45 L (long)**

Item no. 13145-03  
45 mm  
foot height

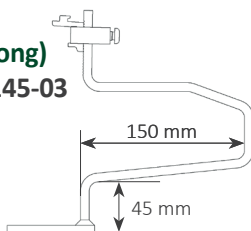

**SL A2-55**

Item no. 13155-01  
55 mm  
foot height

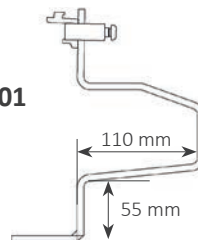

\*Our warranty conditions apply. They are available at [www.sl-rack.com](http://www.sl-rack.com)

## Dimensions

|                          | a     | b      | c      | d     | e      | f     |
|--------------------------|-------|--------|--------|-------|--------|-------|
| <b>SL A2-35</b>          | 35 mm | 110 mm | 124 mm | 60 mm | 150 mm | 9 mm  |
| <b>SL A2-45</b>          | 45 mm | 110 mm | 134 mm | 60 mm | 150 mm | 9 mm  |
| <b>SL A2-45 X</b>        | 45 mm | 120 mm | 143 mm | 80 mm | 180 mm | 11 mm |
| <b>SL A2-45 L (long)</b> | 45 mm | 150 mm | 136 mm | 80 mm | 180 mm | 11 mm |
| <b>SL A2-55</b>          | 55 mm | 110 mm | 156 mm | 60 mm | 150 mm | 9 mm  |

**SL A2:**

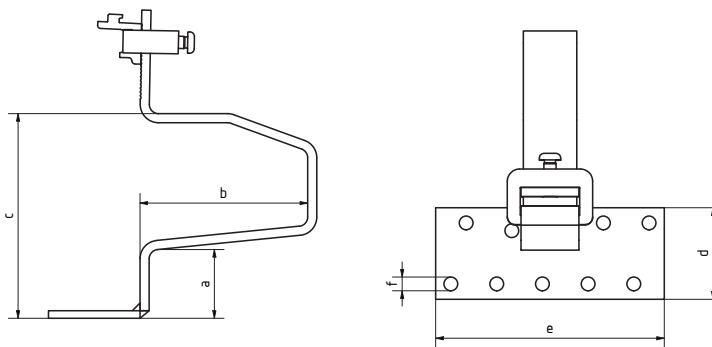

## Accessories



**Clamp Combination, vertical**  
Item no. 11105-05



**Shim for Roof Hooks 2 mm**  
Item no. 94701-02



**Shim for Roof Hooks 5 mm**  
Item no. 94701-05

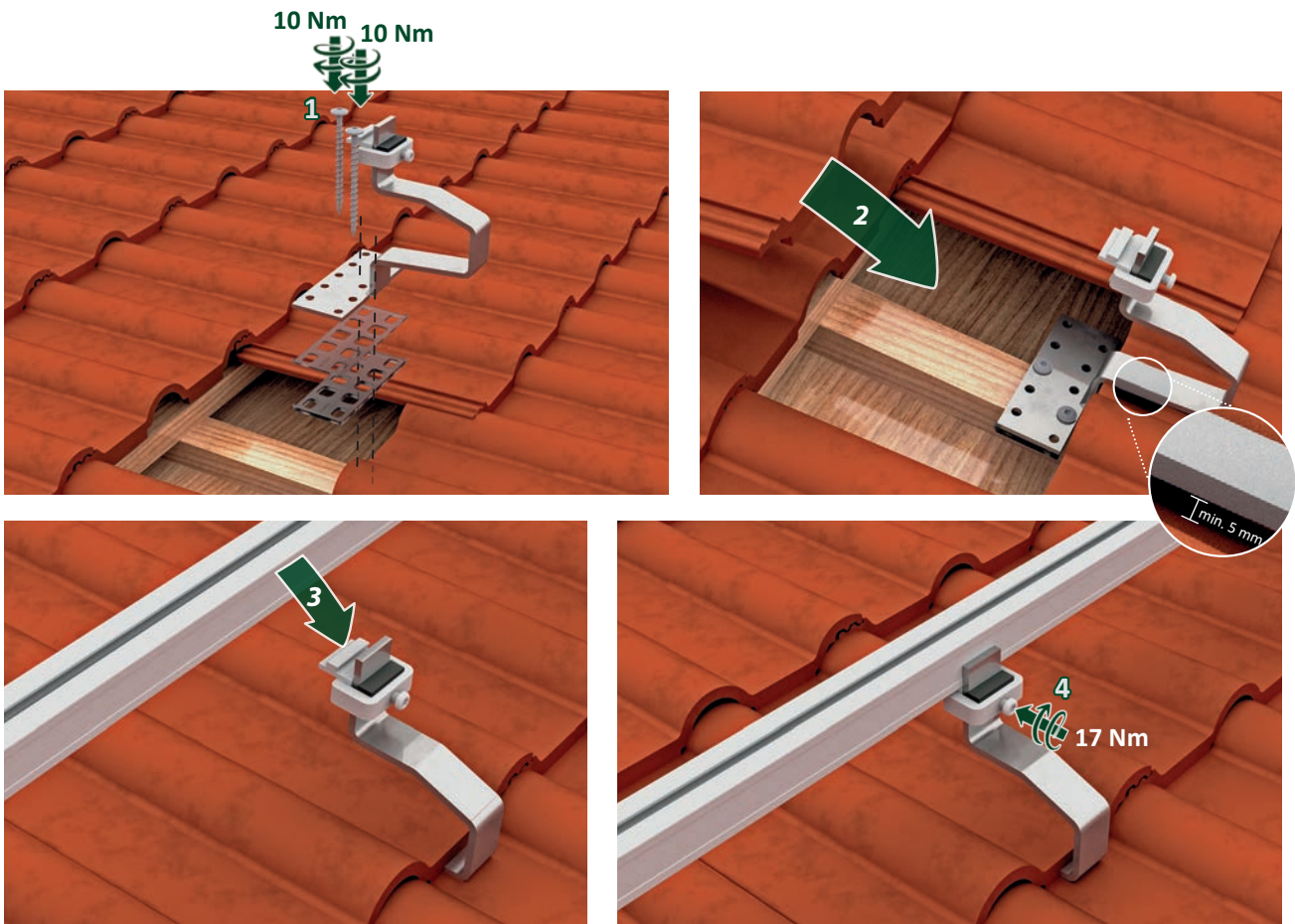

## Installation

1. Remove tiles, pre-drill screw holes and fasten base plate to the rafter with a minimum of 2 wood screws (at least 1 screw per horizontal row of holes, 10 Nm). If necessary, use shims to ensure a minimum distance of 5 mm between bracket and tile is adhered to. As usual, use an angle grinder to grind the top and bottom tile where the bracket exits.
2. Put the tiles back in place
3. Place the rail onto the Clamp Combaion. If necessary adjust the hight on the roof hook.
4. Fixate the rail by tightening the connection with 17 Nm - Done!

## Rafter Width

|                   | Wood Screw $\varnothing$ 6 mm | Wood Screw $\varnothing$ 8 mm |
|-------------------|-------------------------------|-------------------------------|
| SL A2-35          | Min. 46 mm resp. 56 mm*       | Min. 58 mm resp. 68 mm*       |
| SL A2-45          | Min. 46 mm resp. 56 mm*       | Min. 58 mm resp. 68 mm*       |
| SL A2-45 X        | Min. 46 mm resp. 56 mm*       | Min. 58 mm resp. 68 mm*       |
| SL A2-45 L (long) | Min. 46 mm resp. 56 mm*       | Min. 58 mm resp. 68 mm*       |
| SL A2-55          | Min. 46 mm resp. 56 mm*       | Min. 58 mm resp. 68 mm*       |

Table only valid in conjunction with pre-drilling

\*depending on bore combination:  
Screw diameter 6mm - Drill hole  $\varnothing$  4.0mm  
Screw diameter 8mm - Drill hole  $\varnothing$  5.0mm



## Technical Data

|                    |  |
|--------------------|--|
| <b>Material</b>    | Stainless steel (welded), Aluminum (Clamp Combination)   |
| <b>Design Tool</b> | SL-Rack-Configurator <b>Solar.Pro.Tool</b> .   |
| <b>Statik</b>      | The structural analysis is carried out in accordance with the current country-specific standards (EN 1991, EC1 for Germany). Depending on snow loads, wind loads, or when utilizing large modules, it may be necessary to use more than the usual 4 fastening points. Make sure to observe the installation manual of the respective module manufacturer. The load-bearing capacity of the roof has not been evaluated by SL Rack. |

**Your opinion is important to us!**

It is our top priority to make the installation process for you as quick, easy and efficient as possible. Please share your experiences, ideas or criticism with us, so we can continue to improve our products and develop new ones.



SL Rack **Feedback**  
[Provide Feedback >](#)



SL Rack **Website**  
[Check it out >](#)



SL Rack **YouTube**  
[Watch videos >](#)

Find us on



Subject to technical  
changes and misprints.  
Version 06/2023 V14