

FOR CONCRETE ROOF TILES



UNIQUE ON THE MARKET

Your advantages with our products

- » Universal roof replacement panel for almost any type of tile
- » Up to 60 % reduction of roof attachments
- » Suitable for high snow loads (up to 1.500 kg)
- » Optimized warehousing
- » Mechanical cutting unnecessary; no more broken tiles!
- » Min. width of rafter only 36 mm (when using M6 screws)
- » Height of rail easily adjustable with pre-installed Clamp Combination (switch with Clamp Combination vertical, Item no. 11105-05 for a vertical rail installation)
- » Installer-friendly “top-down” design: just place the rail onto the Clamp Combination. One screw fixates the rail and locks in the height at the same time.
- » Only one tool required: Torx 40
- » Sealed with a riveted, UV-resistant EPDM rubber sleeve and raised panel sides
- » Wind calmed zones are created in the corrugated depressions; this allows the water to flow straight downwards
- » Integrated snow- and ice deflector
- » Installation as single- or cross-rail system

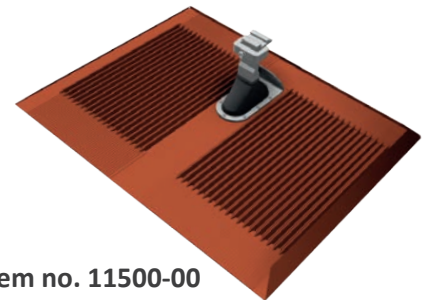

Item no. 11500-00

Color: Brick Red

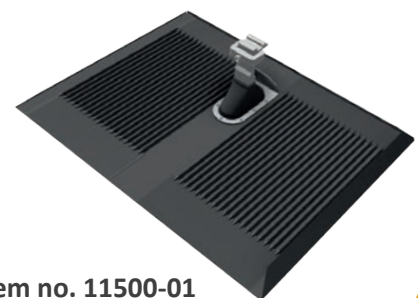

Item no. 11500-01

Color: Anthracite



*Our warranty conditions apply. These can be viewed at any time online at www.sl-rack.de

Dimensions

	a	b	c
Alpha-Plate	457 mm	152 mm	586 mm

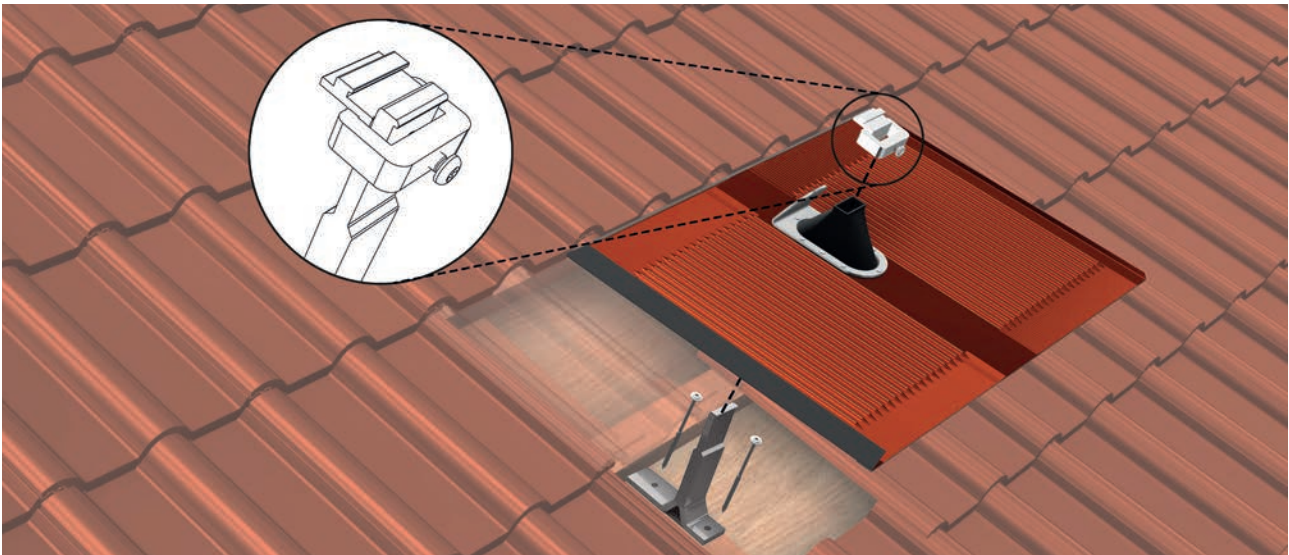
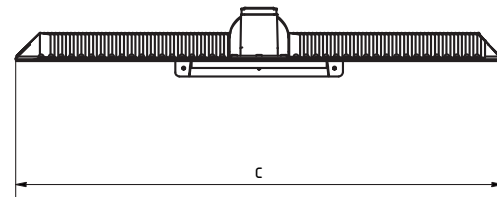
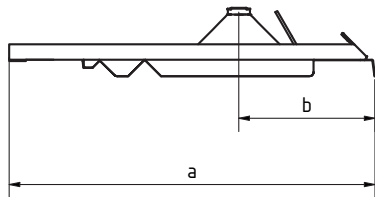

Before you get started, please note the following!

- » Minimum roof pitch 10°, as per ZVDH ; ZVDH specifications regarding the sub-roof must be observed.
- » Roof tiles must be dry and free from debris during the installation in order to achieve a waterproof connection.
- » **The tile should not be longer than the Alpha-Plate (check dimension a).**
- » **Tiles with interlocking pyramids on the bottom and extreme bead differences/ waviness are not compatible**
- » **Avoid the formation of water pockets, which would hinder proper water drainage.**
- » Alpha-Plates must not be installed **directly** one above the other, they should be offset.
- » The Alpha-Plate is not a substitute for a verge tile; it must be moved inwards by one tile, possibly with the help of the rafter spanning profile.
- » Special approvals upon request
- » Please send your inquiry regarding tiles to sales@sl-rack.de

Accessories

» **Alpha-Flex 120**
Item no. 11512-00

- Mounting plate for console
- Lateral adjustability
- Grounding lug can be attached
- Incl. Alpha-Flex-Console Mounting Clamp

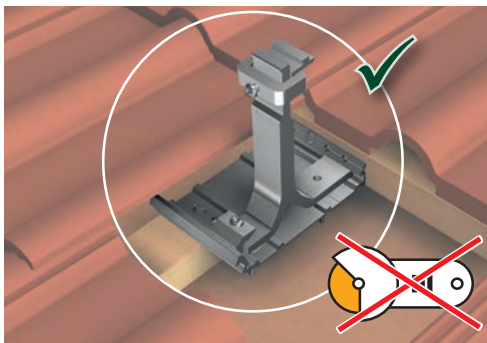
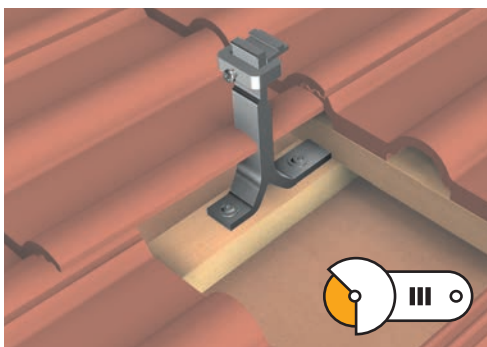

» **Foam wedge**
Item no. 97401-00

- Optional component for rodent protection for extreme types of tiles
- Self-adhesive full foam strip
- Malleable structure
- Made of rot-proof net foam

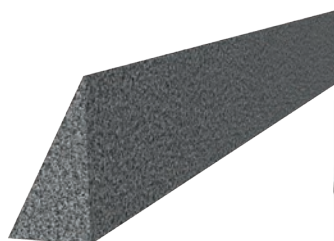

Optional foam wedge for Alpha- & Beta-Plate
Item no. 97401-00

» **Alpha-Flex 2000**
Item no. 11501-2000

- Profile can span the width of up to 2 rafters (required in case an appropriate attachment for the console or mounting plate is not available)
- Better load distribution if multiple consoles are utilized
- Lateral adjustability
- Grounding lug can be attached



Optional Vertical Clamp Combination
Item no. 11105-05



Optional Potential Equalization Clamp for SL Alu and Alpha-Flex
Item no. 11101-20



Optional mounting plate Alpha-Flex 120 incl. Alpha-Flex-Console Mounting Clamp
Item no. 11512-00



Optional Alpha-Flex-Console Mounting Clamp
Item no. 11501-02



Optional Rafter Spanning Profile Alpha-Flex 2000
Item no. 11501-2000



**Alpha-Plate
Installation Video**

Installation

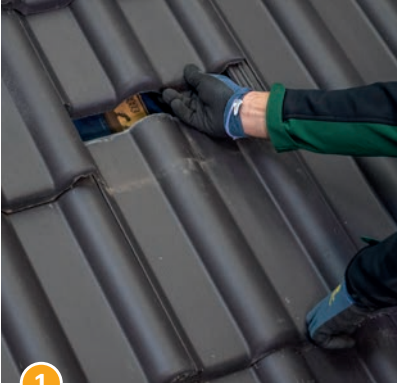

1
Remove tiles in the installation area (max. 3 tiles) and position the remaining tiles...

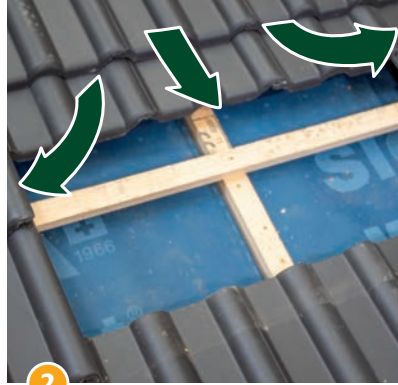

2
...under the top row so that the cross batten is easily visible and accessible.



3a
Slide the long side of the console against the roof batten, which serves as a reference point.

ALTERNATIVE ATTACHMENT WITH ALPHA-FLEX 120

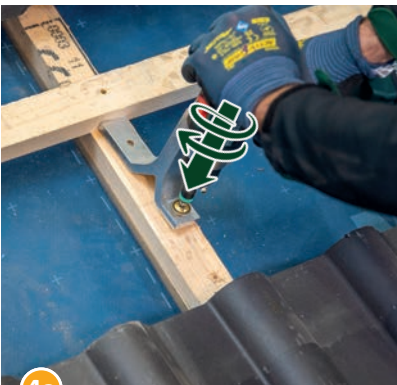

4a
Attach the console with 2 wood screws.
Proceed to step 10.



3b
With the groove facing upwards, position Alpha-Flex on the roof batten, offsetting it left/right and attaching it with a min. of 3 wood screws.



4b
Insert the long side of the console into the upper groove of the Alpha-Flex.

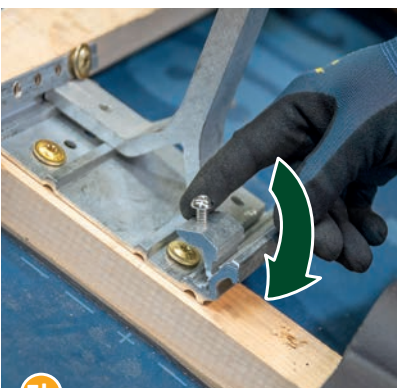

5b
Hook the Alpha-Flex-Console Mounting Plate in...

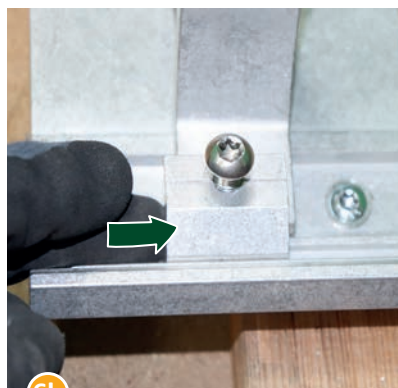

6b
...and center it over the console.



7b
Fixate it by tightening the bolt with 10 Nm.



Alpha-Plate
Installation Video

Installation

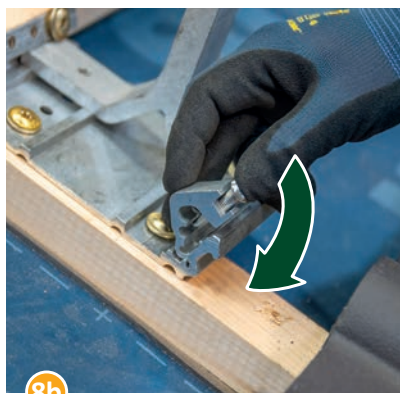

8b
Optional: Hook the Potential Equalization Clamp into the bottom of the Alpha-Flex and tilt it forward.



9b
Insert the cable and fixate the position by tightening the bolt to 10 Nm.



10
Determine the height of the roof tile (DH), that needs to be compensated.

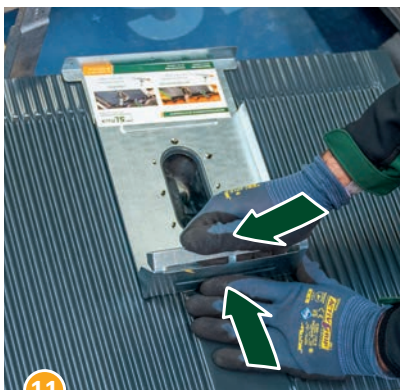

11
Adjust the height of the Alpha-Plate by bending the support plate on the back accordingly.



12
Height of roof tile (DH) = Height of support plate (SH).



13
Place the opening in the support plate on the upper horizontal batten and put the Alpha-Plate with its riveted sealing sleeve over the console.

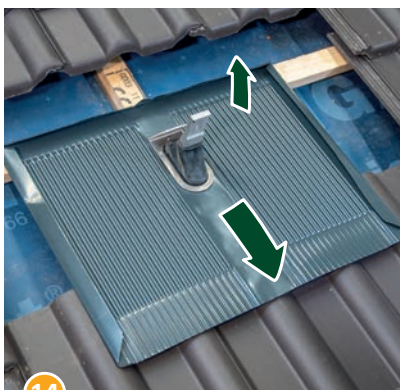

14
Align the Alpha-Plate and ensure that there are no unintentional indentations in the top and center area, which could lead to the formation of water pockets. Press the rear sheet metal edging slightly backwards, in case there is no full coverage of the upper upstand.

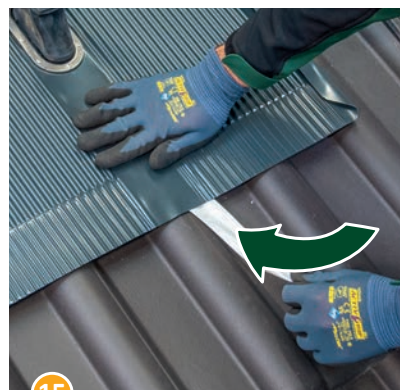

15
Completely peel off the protective paper from the adhesive strip on the back of the Alpha-Plate;
Make sure the surface to be bonded to is dry, clean and dust-free!



16
Starting from the center and working outwards, press down the Alpha-Plate firmly and form-fitting...





Alpha-Plate
Installation Video

Installation



17 ...making sure no water pockets can form in the top and center area.



18 Peel off the protective paper from the adhesive strip on the foam wedge (*Item no. 97401-00*) and stick the foam wedge to the upper side of the metal edge.



19 Put all tiles...



20 ... back into place.



21 Additionally secure the top of the sealing sleeve by using the hose clamp (*Item no. 11502-00-06*). Place the clamp into the groove of the sleeve and tighten it.

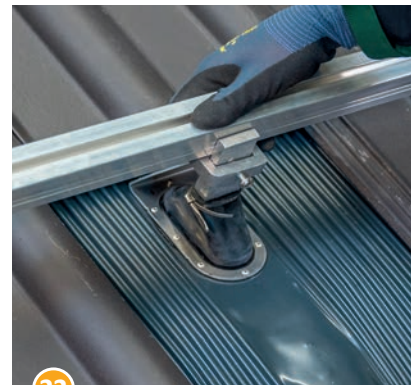

22 Slide the Clamp Combination over the console, drop the rail on top and push it in. Adjust the height through positioning the Clamp Combination on the console.



23 Now fixate the position by tightening the bolt to 15 Nm.

Done!



Technical specifications

Material	Rolled aluminum sheet metal, EPDM rubber sleeve, aluminum (console, clamp combination, snow- and ice deflector), galvanized steel (support plate).
Design Tool	SL-Rack- Configurator Solar.Pro.Tool .
Statics	The structural analysis is carried out in accordance with the current country-specific standards (EN 1991, EC1 for Germany). Depending on snow loads, wind loads, or when utilizing large modules, it may be necessary to use more than the usual 4 fastening points. Make sure to observe the installation manual of the respective module manufacturer. The load-bearing capacity of the roof has not been evaluated by SL Rack.

Your opinion is important to us!

It is our top priority to make the installation process for you as quick, easy and efficient as possible. Please share your experiences, ideas or criticism with us, so we can continue to improve our products and develop new ones.



SL Rack **Feedback**
[Write feedback »](#)



SL Rack **Website**
[Find out more »](#)



SL Rack **YouTube**
[View videos »](#)

Visit us at



Subject to technical changes
and misprints.
Version 05/2024 V21